

Swirling Cavity Flow of Water through a Straight Circular Pipe. III

Toshihiko IKEDA*

(Received October 31, 1972)

1. Introduction

When a liquid flow through a pipe has a large swirling component, a hollow core or cavity is generated at the axis. In the first paper¹⁾ of this series (referred to as I hereafter) it was reported that two different types of cavity flow were observed and that the nature of these flows was influenced by the upstream conditions such as the area parameter σ_0 and the swirl ratio γ . In the second paper²⁾ (referred to as II) some theoretical predictions were made on a simplified model system to show possible dependences of a swirling cavity flow on the upstream conditions.

However, since the flow measurements in I were limited to a single cross-section (at $z=70$ cm) only, it is natural to extend those measurements to find axial variations of the flow structure. Especially, actual upstream conditions just behind the swirl generator and subsequent changes associated with the collapse of cavity are of great interest. This is the motivation of the present report where the results of some measurements made at several different cross-sections will be displayed.

Symbols in I and II are used here as before.

2. Apparatus

The experimental apparatus is shown in Fig. 1. It is almost similar to that used in I. A main difference is that the nose of the swirl generator has been stretched like Fig. 1 for the purpose of simplifying the upstream geometry as far as possible. This modification was found to have little influence on the structure of cavity flows. For additional details, the reader is referred to I.

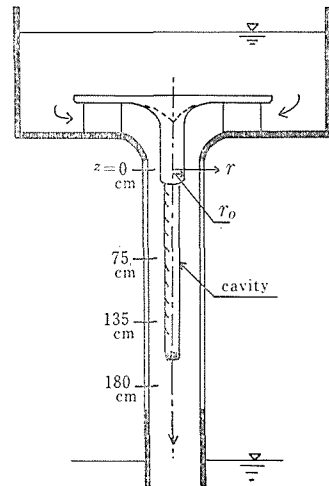

Fig. 1 Apparatus
(in a schematic form)

* Research Associate, Department of Mechanical Engineering

Flow measurements were made by a two-hole pitot-tube traversed transversely at the section $z = 0$ cm, 75 cm, 135 cm and 180 cm, respectively. In the present experiment the area parameter σ_0 was kept constant ($\sigma_0 = 0.75$ or $\alpha = 0.5$), while the previous measurements in I were concerned with three values of the parameter $\sigma_0 = 0.51, 0.75$ and 0.91 . As is understood from Fig. 1, measurements at $z = 0$ cm correspond to the flow just behind the swirl generator, and those at $z = 75$ cm and 135 cm correspond to the flow around the cavity. The pitot-hole at $z = 180$ cm was drilled in order to get informations on the flow behind the cavity. Further, the wall pressure distribution in the z -direction was measured by thirteen pressure taps newly installed at intervals of every 15 cm.

3. Experimental results

Measurements were carried out for several values of the swirl ratio γ by changing the set angle ϑ of the guide vanes. The experimental conditions are tabulated in Table 1 together with some typical quantities.* Under these conditions the cavity, if present, was always of stationary type.**

The experimental relation between ϑ and γ is plotted in Fig. 2, whereas

Table 1 The experimental conditions and other typical quantities for $\sigma_0=0.75$ (or $\alpha=0.5$).

ϑ°	z cm	Q m ³ /sec	r_a cm	\bar{v}_z m/sec	$\gamma =$ $2v_{\theta 1}/\bar{v}_z$	p_w kg/cm ²	p_a kg/cm ²
20	0	0.0709	—	6.34	0.2	0.867	—
	75		0.0	4.73	0.6	1.029	
	135		0.0	4.73	0.5	1.063	
40	0	0.0605	—	5.40	1.1	0.859	0.423
	75		0.9	4.12	1.2	1.026	
	135		0.9	4.12	1.2	1.061	
	180		0.0	4.03	1.1	1.088	
60	0	0.0505	—	4.51	1.8	0.893	0.635
	75		1.6	3.56	2.0	1.010	
	135		1.6	3.56	2.0	1.047	
	180		0.0	3.37	1.9	1.062	

* We are concerned with the mean values, averaging spatial and temporal fluctuations due to boundary perturbations and turbulence.

** See I; section 3, p. 3 and Fig. 3.

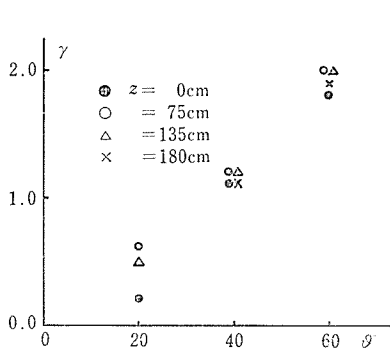

Fig. 2 The swirl ratio γ vs. the set angle of the guide vanes ϑ .

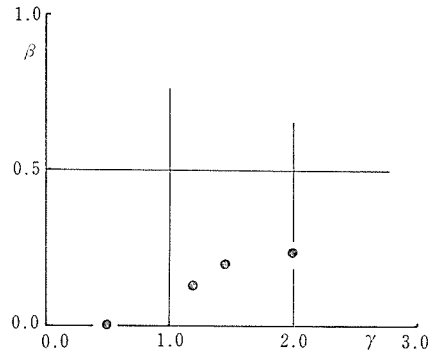

Fig. 3 The cavity radius β vs. the swirl ratio γ .

Fig. 3 shows the dependence of the non-dimensional cavity radius β on γ . It is seen that both relationships are in good agreement with those obtained in I.

The results of the flow measurements are reproduced in Figs. 4 to 14.

At the section $z = 0$ cm (Figs. 4, 7, 11), the total pressure p_t (or k_t in non-dimensional form) and the axial velocity v_z are nearly constant, and the swirl component v_θ is slightly decreasing with η . In comparison with the assumed upstream velocity components in II*, it was thus found that the upstream condition of a rigid body rotation was not established in reality.

At the section $z = 75$ cm and 135 cm (Figs. 5, 6 for $\vartheta = 20^\circ$, Figs. 8, 9 for $\vartheta = 40^\circ$ and Figs. 12, 13 for $\vartheta = 60^\circ$), the pressure and velocity profiles for each values of γ are coincident each other with the similar nature to that described

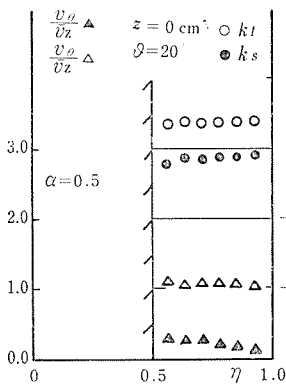

Fig. 4

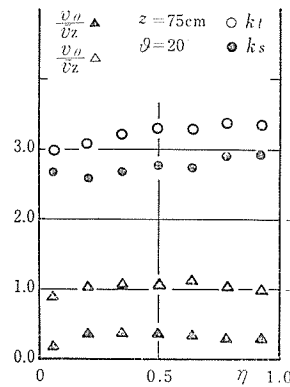

Fig. 5

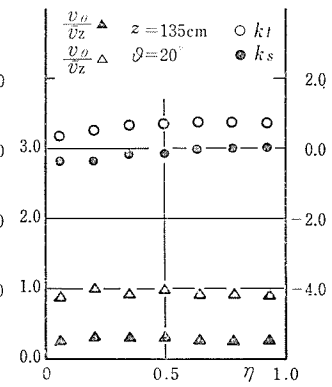

Fig. 6

* That is, $v_z = \text{const.}$ and $v_\theta = \omega r$.

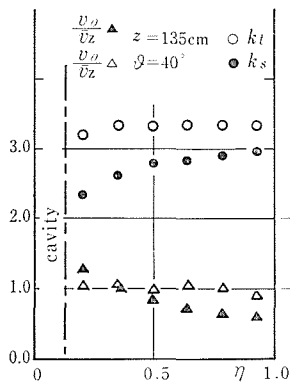

Fig. 7

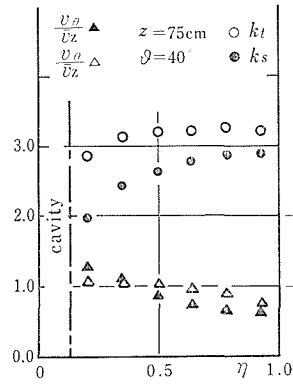

Fig. 8

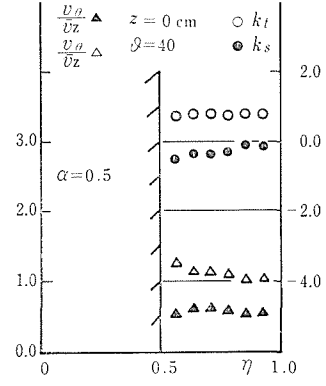

Fig. 9

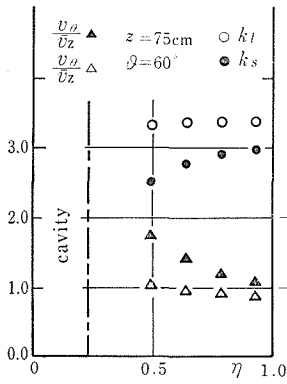

Fig. 10

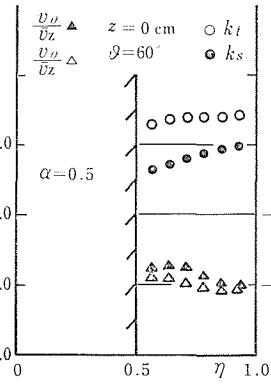

Fig. 11

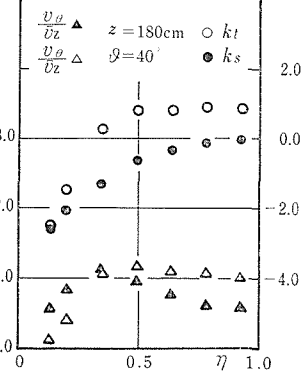

Fig. 12

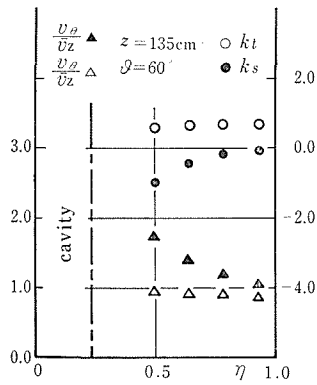

Fig. 13

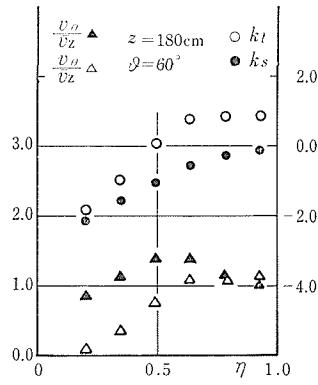

Fig. 14

in I. The flow in this region is, therefore, practically uniform in the z -direction.

From the measurements at $z = 180$ cm (Figs. 10, 14), it is seen that the flow behind the cavity is composed of a forced vortex core and a quasi-potential flow surrounding it. As an interesting observation in this connection, v_z has a very small value within the "shadow" of the cavity. This suggests that the cavity is followed by a "dead-water" wake rotating like a rigid body. Fig. 15 summarizes the circulation profiles.

Lastly, the measured results of the wall pressure p_w , mean axial velocity \bar{v}_z and swirl velocity $v_{\theta 1}$ (at the wall) are shown in Figs. 16, 17. A slight linear increase in the wall pressure p_w (except in the inlet region $z \leq 30$ cm) is roughly

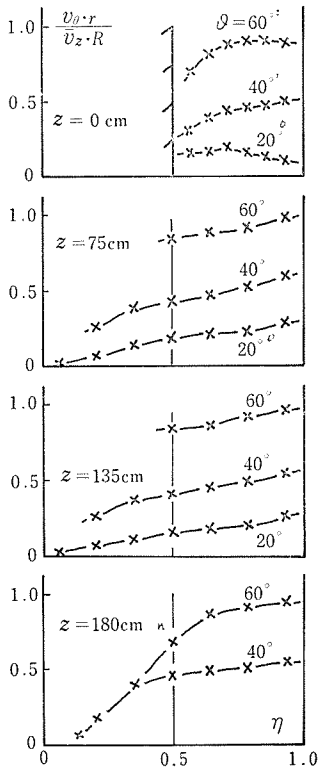

Fig. 15 The circulation distributions

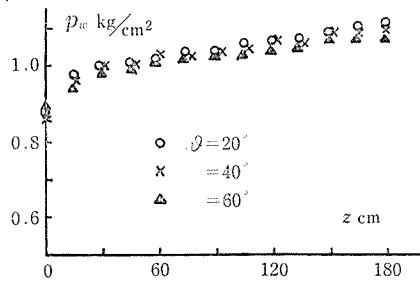

Fig. 16 The wall pressure

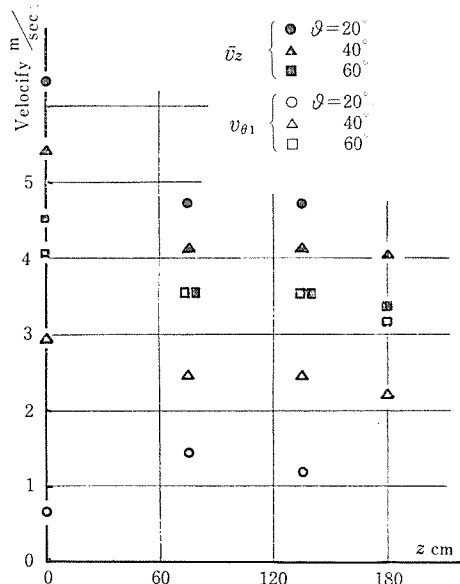

Fig. 17 The mean axial velocity and swirl velocity at wall

consistent with the increase in hydrostatic pressure. Accordingly we may suppose that processes governing these types of flow are essentially energy-conserving. However, the influences of the collapse of cavity are seen in the velocity profiles.

4. Concluding remarks

The previous measurements in I of swirling cavity flow of water was extended to find axial variations of the flow structure. The stationary cavity was observed to collapse downstream, being followed by a spinning dead-water wake. Further experimental findings are recapitulated as follows :

- (i) The upstream condition of a rigid body rotation was not established in reality.
- (ii) The flow around the cavity is practically uniform in the z -direction.
- (iii) The flow behind the cavity is composed of a forced vortex core and a quasi potential flow surrounding it.
- (iv) The wall pressure is slightly increasing with z hydrostatically, and very little influenced by the collapse of cavity.

Deviation from the upstream condition of a rigid body rotation makes the theoretical approach difficult, because the governing equation in II : (1) becomes then nonlinear. An alternative idea will probably be to replace the nose of swirl generator with a cylindrical vortex sheet surrounded by a potential motion. Further points of interest are the collapse of cavity and a finite transition process known as the vortex breakdown.³⁾⁴⁾⁵⁾⁶⁾

The latter problem has been considered by Binnie⁷⁾ and Hashimoto⁸⁾ in the presence of a cavity, and some preliminary computations are now in progress in the present context.

The author wishes to express his hearty thanks to Professor M. Ohji, for his help and guidance in this study and to Assistant Professor H. Takada for his interest in this problem. Thanks are also due to Mr. T. Nishihara and K. Nakamizo for their cooperation in experimental work.

References

- 1) T. Ikeda and M. Ohji, "Swirling cavity flow of water through a straight circular pipe I" *J. Faculty of Engineering Shinshu University, Japan*, No. **32** (1972), pp. 1-9.
- 2) T. Ikeda and M. Ohji, "Swirling cavity flow of water through a straight circular pipe II" *J. Faculty of Engineering Shinshu University, Japan*, No. **32** (1972), pp. 11-22.
- 3) O. M. Phillips, "Centrifugal waves" *J. Fluid Mech.*, Vol. **7** (1960), pp. 340-352.
- 4) J. K. Harvey, "Some observations of the vortex breakdown phenomenon" *J. Fluid Mech.*,

Vol. **14** (1962), pp. 585-592.

- 5) T. B. Benjamin, "Theory of the vortex breakdown phenomenon" *J. Fluid Mech.*, Vol. **14** (1962), pp. 593-629.
- 6) T. Sarpkaya, "On stationary and travelling vortex breakdowns" *J. Fluid Mech.*, Vol. **45** (1971), pp. 545-559.
- 7) A. M. Binnie, "Annular hydraulic jumps" *Proc. Roy. Soc. Lond., Ser. A*, Vol. **282** (1964), pp. 155-165.
- 8) H. Hashimoto, "Breakdown of swirling cavity flow in a circular pipe" *J. Basic Engng., Trans. ASME.*, Ser. **D**, Vol. **93** (1971), pp. 92-95.

ERRATA

From Fig. 4 to Fig. 14, for $\frac{v_\theta}{v_z}$ before the symbol Δ , read $\frac{v_z}{v_z}$.